

SPA Series

700-900MHz 10W RF Power Amplifier

Features

- Frequency Range: 700-900MHz
- Gain: 43dB
- P_{out}: +40dBm
- P_{sat}: +42dBm
- IP3: +49dBm
- DC Power: 12V
- SMA Connector

Performance measured @ 800MHz

Description

SPA-800 is a 10Watt (+40dBm) output RF Power Amplifier operating from single 12V DC power supply with frequency range in 700-900MHz.

Picture

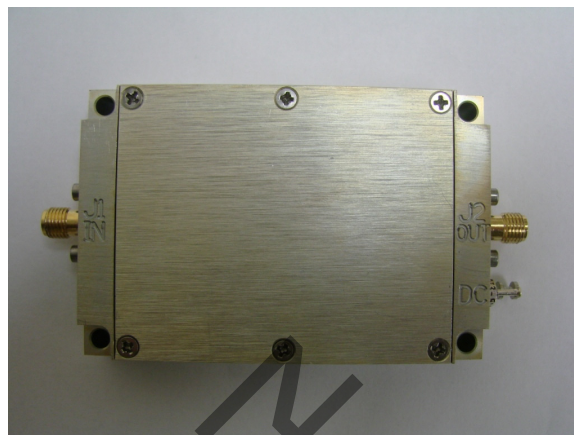

Electrical Specifications @ +25 °C, Z_S = Z_L = 50 Ω, V_{CC} = +12V

Parameter	Unit	Minimum	Typical	Maximum
Frequency Range	MHz	700		900
Small Signal Gain	dB		43	
Output Power P _{out} @ P _{in} = -1dBm	dBm		+40	
Saturated Power P _{sat} @ P _{in} = +3dBm	dBm		+42	
IP3	dBm		+49	
Reverse Isolation	dB		-70	
Efficiency at P _{out} = +40dBm	%		34	
VSWR Input			1.3:1	
DC Power Supply	V		+12	
Supply Current	mA		2700	
Size (Excluding SMA Connector)	inch	3.000" x 2.000" x 0.625"		
Weight	Oz.	4.8 (135g)		

Warning: adequate heatsink required for continuous operation, keep amplifier base plate temperature under +65 °C.

SPA Series

700-900MHz 10W RF Power Amplifier

Typical Performance @ +25 °C

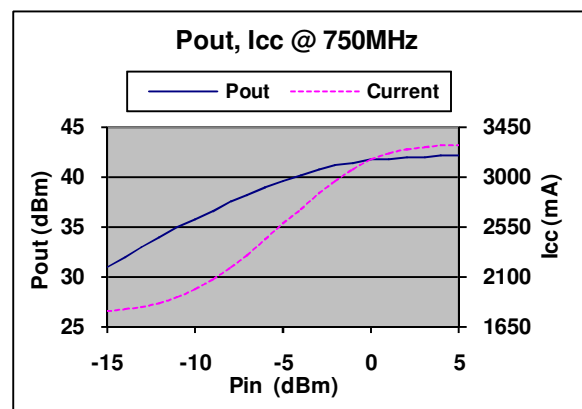
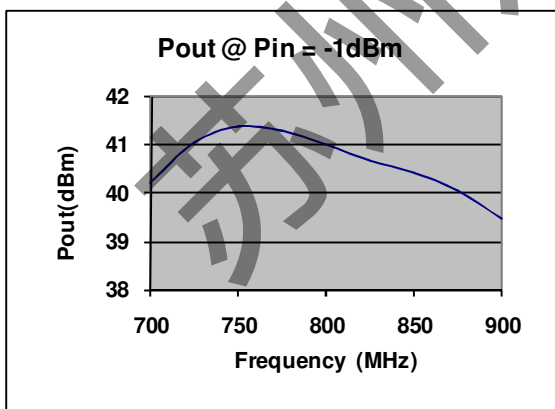
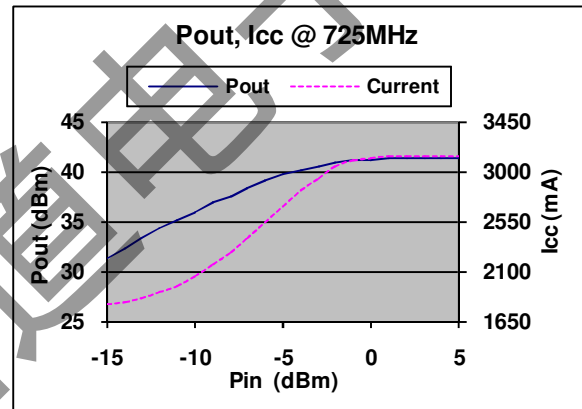
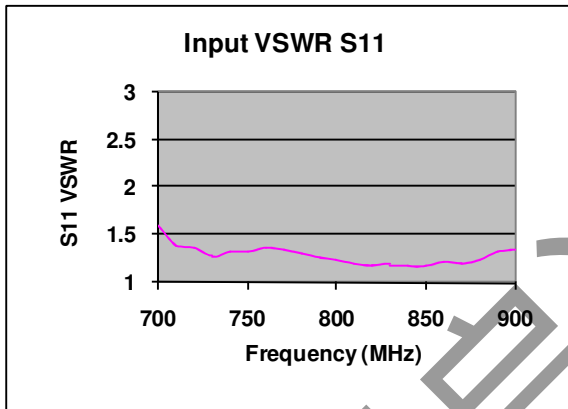
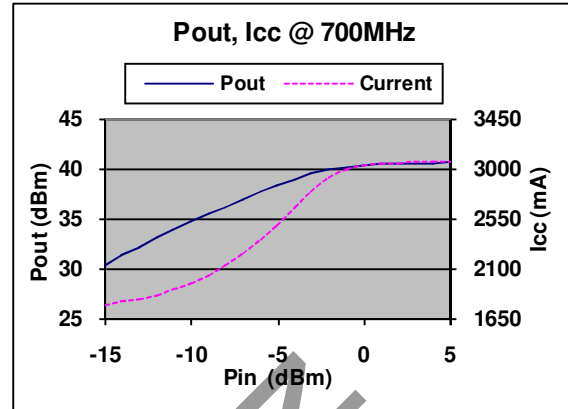
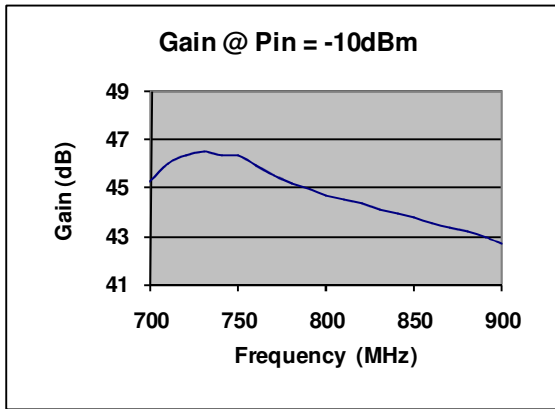

SPA Series

700-900MHz 10W RF Power Amplifier

Typical Performance @ +25 °C

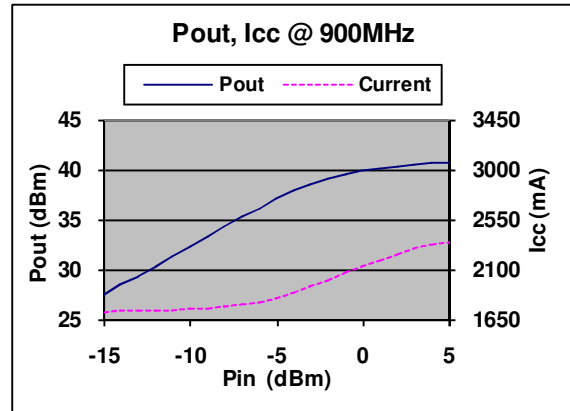
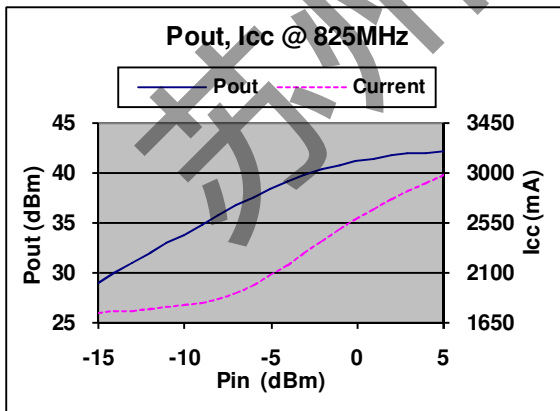
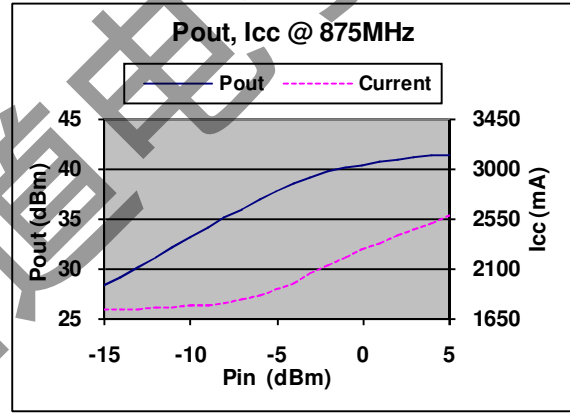
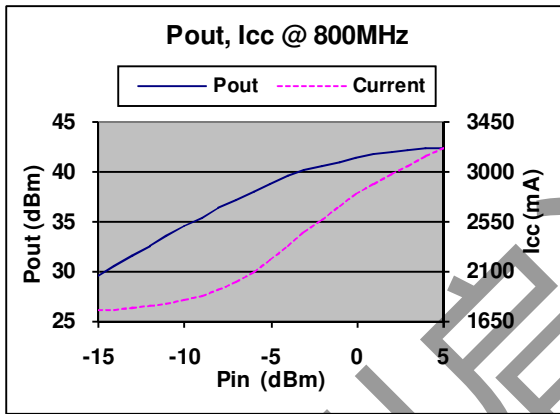
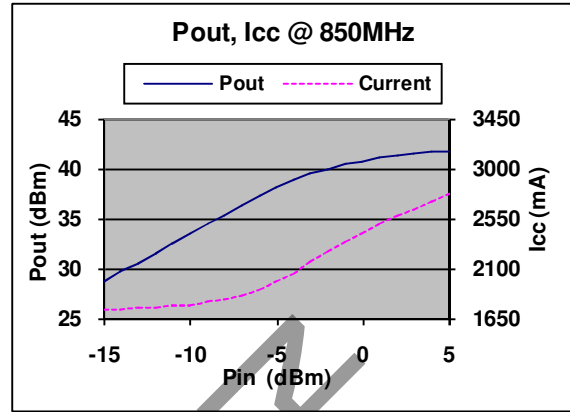
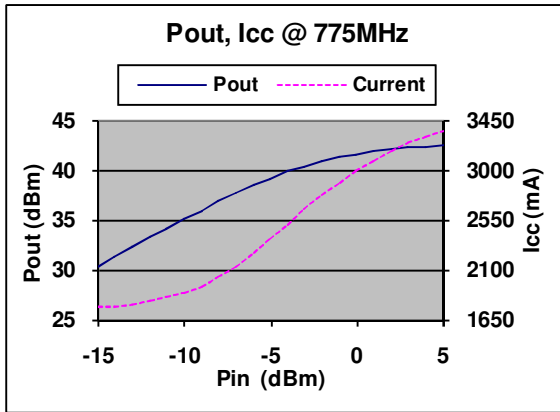

SPA Series

700-900MHz 10W RF Power Amplifier

Absolute Maximum Ratings

Parameter	Absolute Maximum
RF Input Power	+15dBm
Supply Voltage	+16V
Operating Temperature	-30 °C to +65 °C
Storage Temperature	-55 °C to +100 °C

Outline

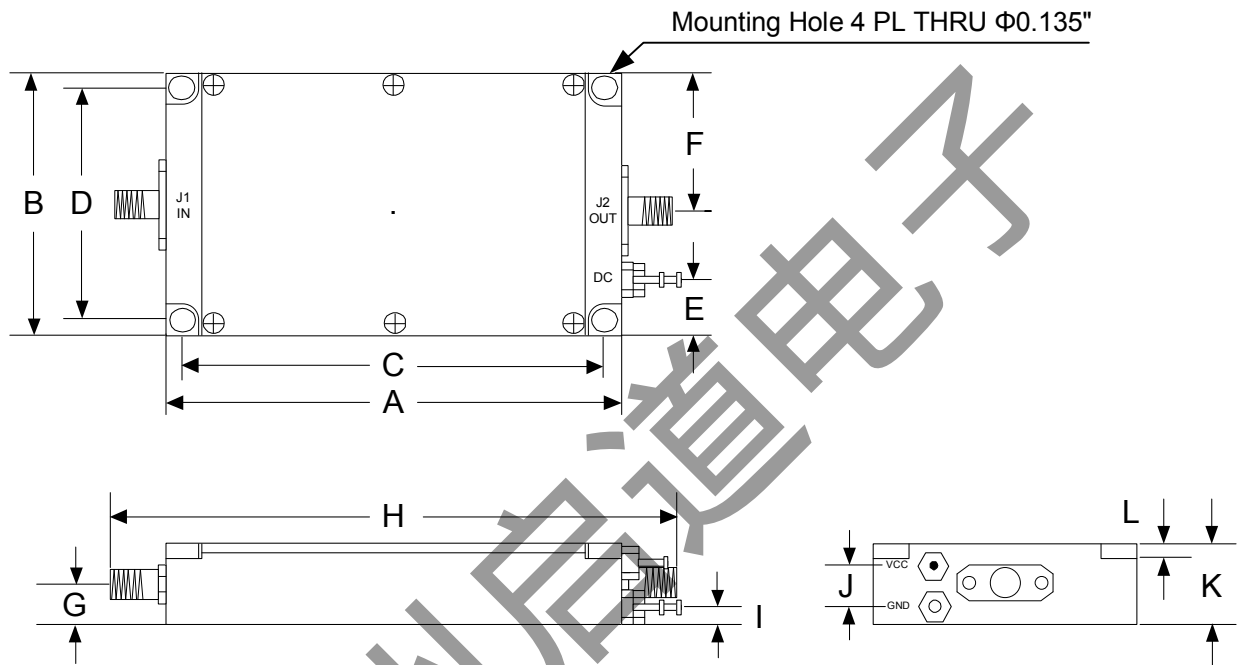

	A	B	C	D	E	F	G	H	I
Inch	3.000	2.000	2.750	1.750	0.500	1.000	0.300	3.750	0.125
mm	76.20	50.80	69.85	44.45	12.70	25.40	7.62	95.25	3.18
	J	K	L						
Inch	0.300	0.625	0.150						
mm	7.62	15.88	3.81						