



0.6 m | 2 ft ValuLine® High Performance Low Profile Antenna, single-polarized, 7.100–8.500 GHz

Product Classification

Product Type	Microwave antenna
Product Brand	ValuLine®

General Specifications

Antenna Type	VHLP - ValuLine® High Performance Low Profile Antenna, single-polarized
Polarization	Single
Side Struts, Included	0
Side Struts, Optional	0

Dimensions

Diameter, nominal	0.6 m 2 ft
--------------------------	--------------

Electrical Specifications

Operating Frequency Band	7.100 – 8.500 GHz
Gain, Low Band	29.6 dBi
Gain, Mid Band	31.1 dBi
Gain, Top Band	32.2 dBi
Boresite Cross Polarization Discrimination (XPD)	32 dB
Front-to-Back Ratio	57 dB
Beamwidth, Horizontal	4.7 °
Beamwidth, Vertical	4.7 °
Return Loss	17.7 dB
VSWR	1.3
Radiation Pattern Envelope Reference (RPE)	7199C

Electrical Compliance

Brazil Anatel Class 2 | ETSI 302 217 Class 3

Mechanical Specifications

Compatible Mounting Pipe Diameter

50 mm–120 mm | 2.0 in–4.7 in

Fine Azimuth Adjustment Range

±15°

Fine Elevation Adjustment Range

±15°

Wind Speed, operational

180 km/h | 111.847 mph

Wind Speed, survival

250 km/h | 155.343 mph

Antenna Dimensions and Mounting Information

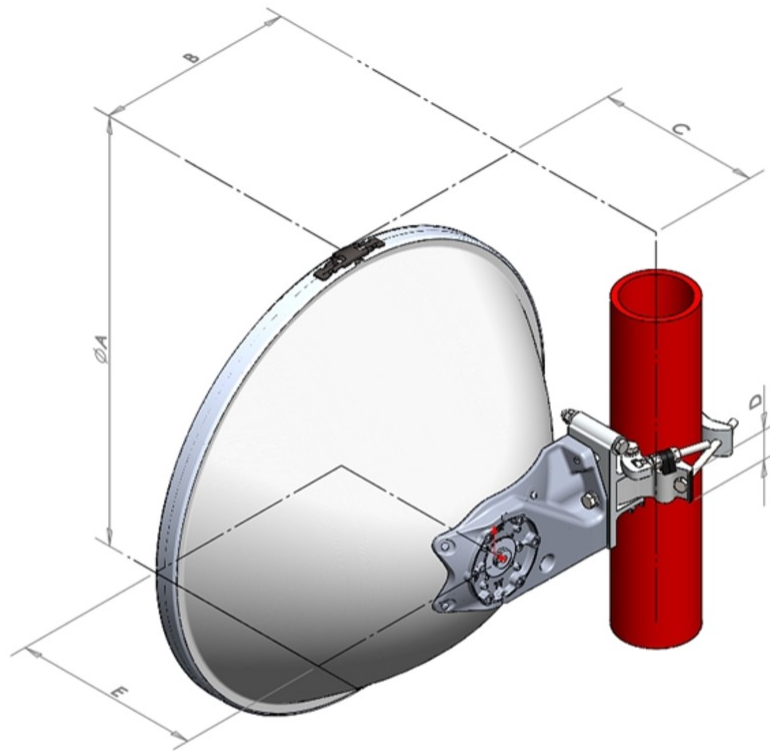

I

Dimension in Inches (mm)					
Antenna size, ft (m)	A	B	C	D	E
2 (0.6)	26 (660)	11.9 (307)	9.9 (252)	1.8 (45)	11.4 (289)

Wind Forces at Wind Velocity Survival Rating

Axial Force (FA)	1290 N 290.004 lbf
Side Force (FS)	639 N 143.653 lbf
Twisting Moment (MT)	395 N-m 3,496.045 in lb
Zcg without Ice	74 mm 2.913 in
Zcg with 1/2 in (12 mm) Radial Ice	106 mm 4.173 in
Weight with 1/2 in (12 mm) Radial Ice	21 kg 46.297 lb

Wind Forces at Wind Velocity Survival Rating Image

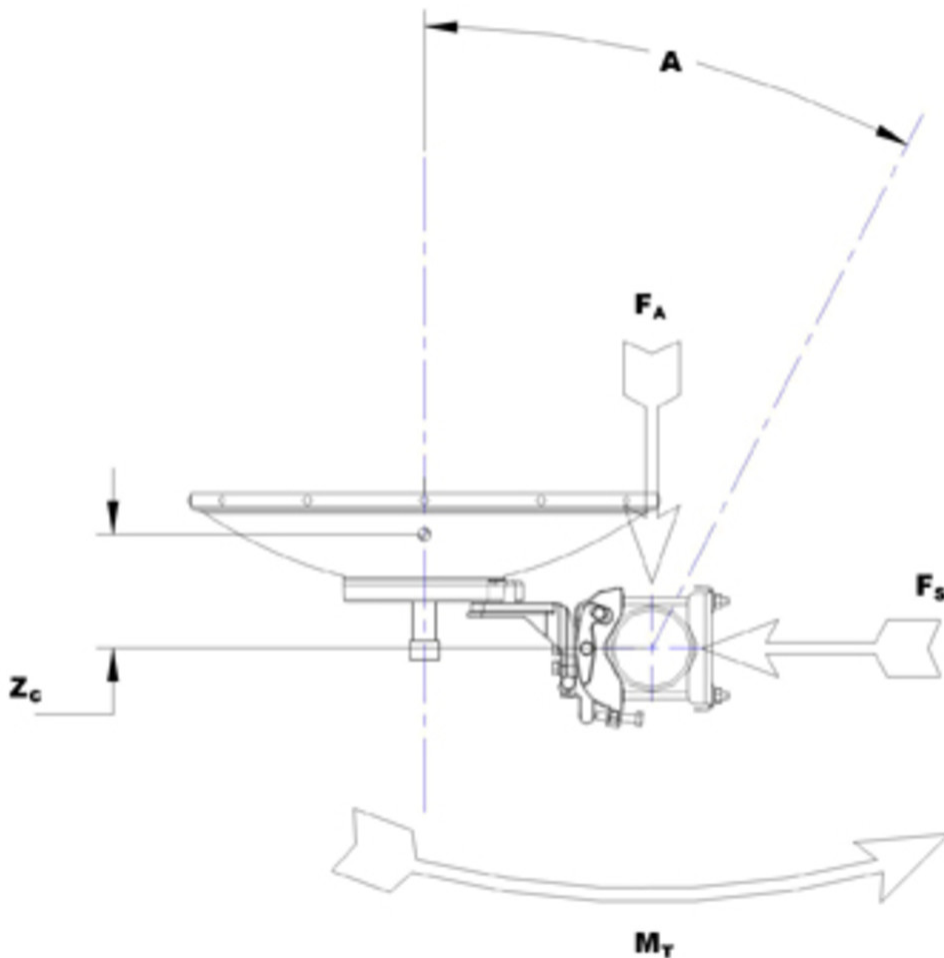

Packaging and Weights

Weight, net

8 kg | 17.637 lb

Regulatory Compliance/Certifications

Agency

ISO 9001:2015

Classification

Designed, manufactured and/or distributed under this quality management system



* Footnotes

Operating Frequency Band

Bands correspond with CCIR recommendations or common allocations

used throughout the world. Other ranges can be accommodated on special order.

Gain, Mid Band

For a given frequency band, gain is primarily a function of antenna size. The gain of Andrew antennas is determined by either gain by comparison or by computer integration of the measured antenna patterns.

Boresite Cross Polarization Discrimination (XPD)

The difference between the peak of the co-polarized main beam and the maximum cross-polarized signal over an angle twice the 3 dB beamwidth of the co-polarized main beam.

Front-to-Back Ratio

Denotes highest radiation relative to the main beam, at $180^\circ \pm 40^\circ$, across the band. Production antennas do not exceed rated values by more than 2 dB unless stated otherwise.

Return Loss

The figure that indicates the proportion of radio waves incident upon the antenna that are rejected as a ratio of those that are accepted.

VSWR

Maximum; is the guaranteed Peak Voltage-Standing-Wave-Ratio within the operating band.

Radiation Pattern Envelope Reference (RPE)

Radiation patterns define an antenna's ability to discriminate against unwanted signals. Under still dry conditions, production antennas will not have any peak exceeding the current RPE by more than 3dB, maintaining an angular accuracy of $\pm 1^\circ$ throughout

Wind Speed, operational

For VHLP(X), SHP(X), HX and USX antennas, the wind speed where the maximum antenna deflection is 0.3 x the 3 dB beam width of the antenna. For other antennas, it is defined as a deflection is equal to or less than 0.1 degrees.

Wind Speed, survival

The maximum wind speed the antenna, including mounts and radomes, where applicable, will withstand without permanent deformation. Realignment may be required. This wind speed is applicable to antenna with the specified amount of radial ice.

Axial Force (FA)

Maximum forces exerted on a supporting structure as a result of wind from the most critical direction for this parameter. The individual maximums specified may not occur simultaneously. All forces are referenced to the mounting pipe.

Side Force (FS)

Maximum side force exerted on the mounting pipe as a result of wind from the most critical direction for this parameter. The individual maximums specified may not occur simultaneously. All forces are referenced to the mounting pipe.

Twisting Moment (MT)

Maximum forces exerted on a supporting structure as a result of wind from the most critical direction for this parameter. The individual maximums specified may not occur simultaneously. All forces are referenced to the mounting pipe.